CS380: Computer Graphics Modeling Transformations

Sung-Eui Yoon
(윤성의)

Course URL:
<http://sgvr.kaist.ac.kr/~sungeui/CG/>

KAIST

The KAIST logo consists of the word "KAIST" in a bold, blue, sans-serif font. Below the text is a horizontal blue oval shape that tapers at both ends, serving as a shadow or underline for the text.

Class Objectives (Ch. 3.5)

- **Know the classic data processing steps, rendering pipeline, for rendering primitives**
- **Understand 3D translations and rotations**

Outline

- **Where are we going?**
 - **Sneak peek at the rendering pipeline**
- **Vector algebra**
- **Modeling transformation**
- **Viewing transformation**
- **Projections**

The Classic Rendering Pipeline



- Object **primitives** defined by vertices fed in at the top
- Pixels come out in the display at the bottom
- Commonly have multiple primitives in various stages of rendering

Modeling Transforms



- Start with 3D models defined in **modeling spaces** with their own **modeling frames**: $m_1^t, m_2^t, \dots, m_n^t$
- Modeling transformations orient models within a common coordinate frame called **world space**, w^t
 - All objects, light sources, and the camera live in world space
- **Trivial rejection** attempts to eliminate objects that cannot possibly be seen
 - An optimization

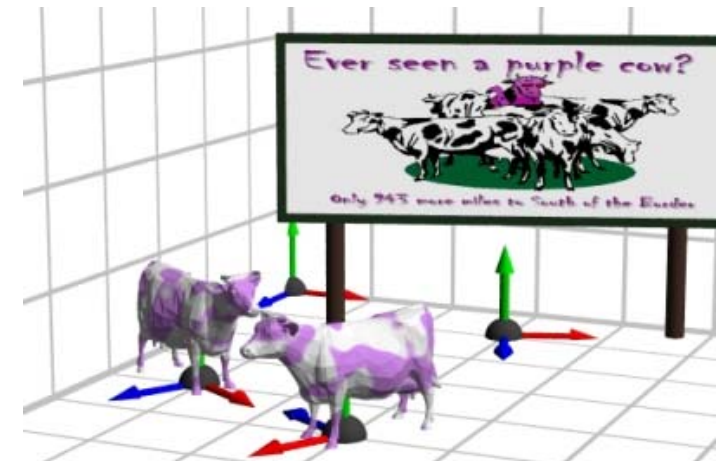

Illumination



- **Illuminate potentially visible objects**
- **Final rendered color is determined by object's orientation, its material properties, and the light sources in the scene**

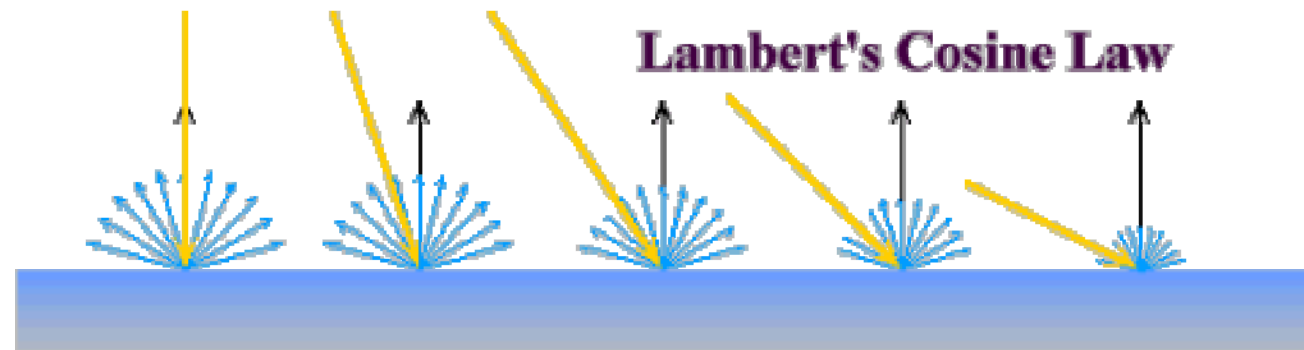

Viewing Transformations



- **Maps points from world space to eye space:**

$$\dot{e}^t = \dot{w}^t V$$

- **Viewing position is transformed to the origin**
- **Viewing direction is oriented along some axis**

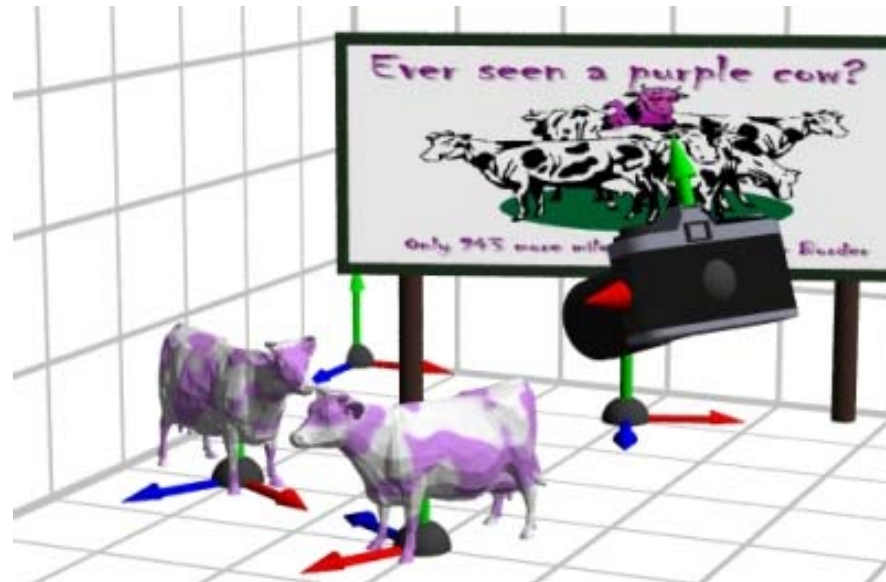

Clipping and Projection



- We specify a volume called a *viewing frustum*
- Clip objects against the view volume, thereby eliminating geometry not visible in the image
- Project objects into two-dimensions

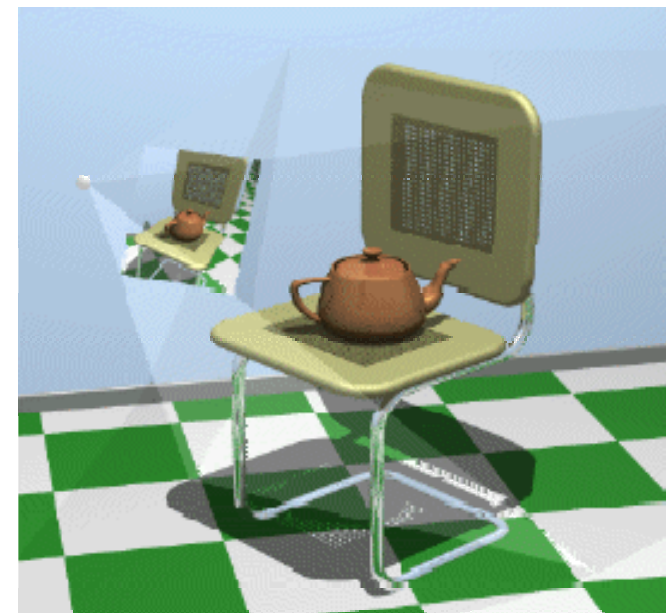

Rasterization and Display

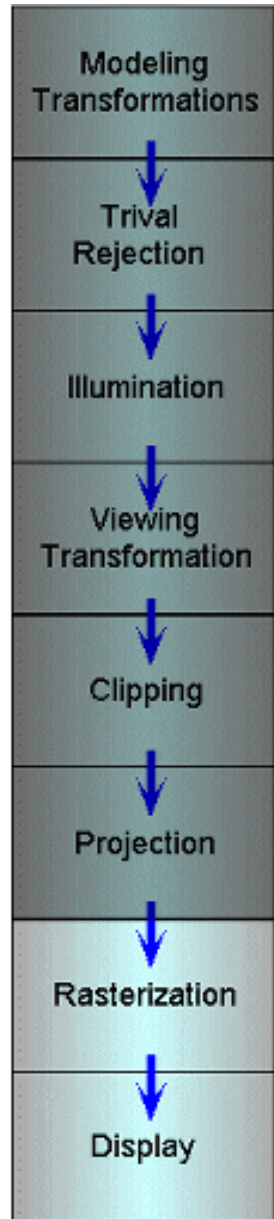

- **Rasterization converts objects pixels**

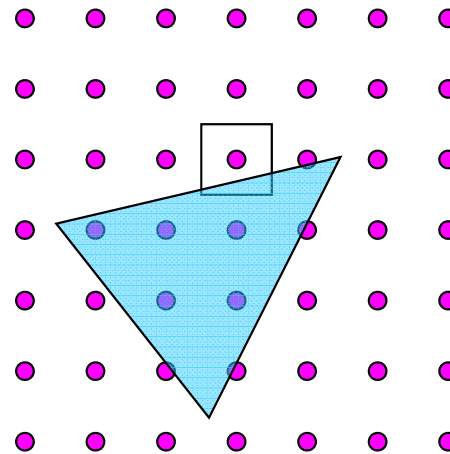

- **Almost every step in the rendering pipeline involves a change of coordinate systems!**
- **Transformations are central to understanding 3D computer graphics**

But, this is a architectural overview of a recent GPU (Fermi)

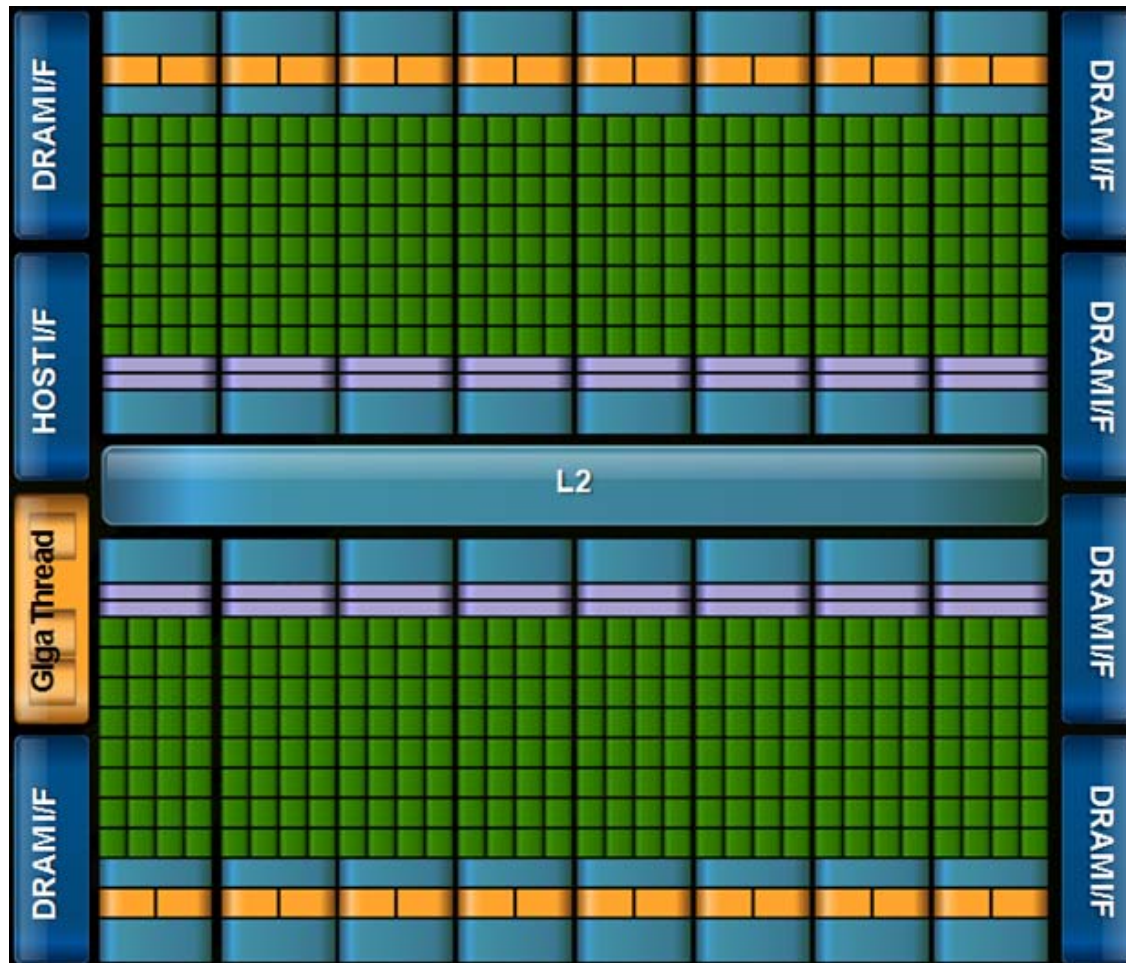

- **Highly parallel**
- **Wide memory bandwidth**
- **Support CUDA (general language)**

Recent CPU Chips (Intel's Core i7 processors)

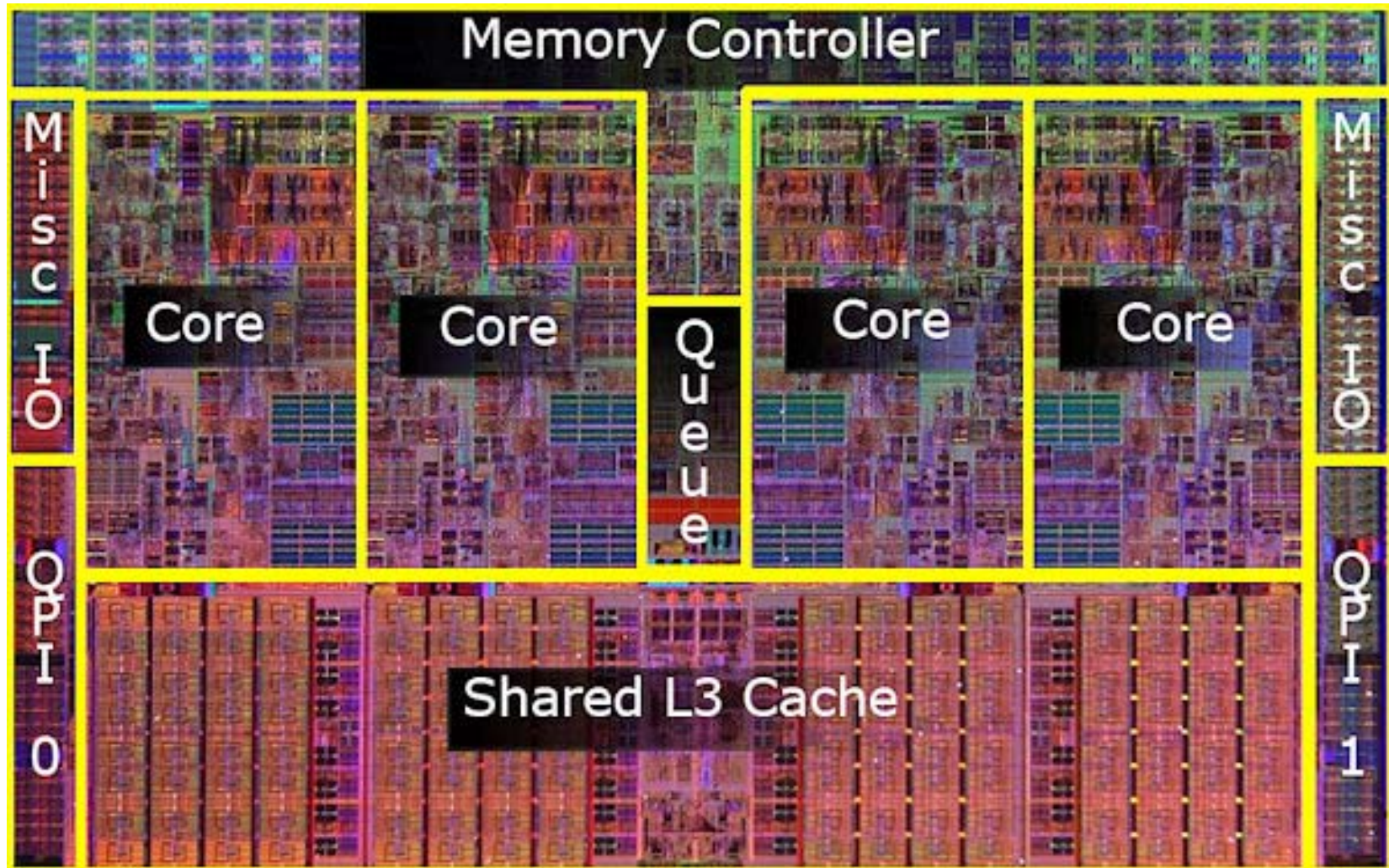

Vector Algebra

- **Already saw vector addition and multiplications by a scalar**
- **Discuss two kinds of vector multiplications**
 - **Dot product (\cdot)** - returns a scalar
 - **Cross product (\times)** - returns a vector

Dot Product (\cdot)

$$\vec{a} \cdot \vec{b} \equiv \vec{a}^T \vec{b} = \begin{bmatrix} a_x & a_y & a_z & 0 \end{bmatrix} \begin{bmatrix} b_x \\ b_y \\ b_z \\ 0 \end{bmatrix} = s, \quad \vec{a} \cdot \vec{b} \equiv \vec{a}^T \vec{b} = \begin{bmatrix} a_x & a_y & a_z & 0 \end{bmatrix} \begin{bmatrix} b_x \\ b_y \\ b_z \\ 1 \end{bmatrix} = s$$

- Returns a scalar s
- Geometric interpretations s :
 - $\vec{a} \cdot \vec{b} = |\vec{a}| |\vec{b}| \cos\theta$
 - Length of \vec{b} projected onto \vec{a} or vice versa
 - Distance of \vec{b} from the origin in the direction of \vec{a}

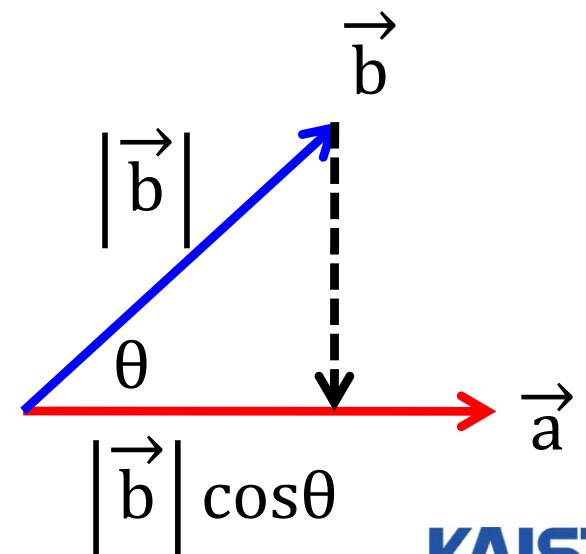

Cross Product (\times)

$$\vec{a} \times \vec{b} \equiv \begin{bmatrix} 0 & -a_z & a_y & 0 \\ a_z & 0 & -a_x & 0 \\ -a_y & a_x & 0 & 0 \\ 0 & 0 & 0 & 0 \end{bmatrix} \begin{bmatrix} b_x \\ b_y \\ b_z \\ 0 \end{bmatrix} = \vec{c} \quad \begin{array}{l} \vec{a} \cdot \vec{c} = 0 \\ \vec{b} \cdot \vec{c} = 0 \end{array}$$

$$\vec{c} = [a_y b_z - a_z b_y \quad a_z b_x - a_x b_z \quad a_x b_y - a_y b_x]$$

- **Return a vector \vec{c} that is perpendicular to both \vec{a} and \vec{b} , oriented according to the right-hand rule**

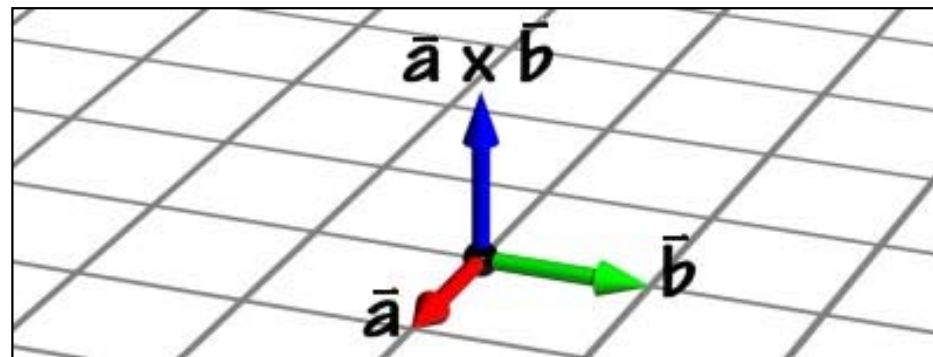

Cross Product (\times)

- A mnemonic device for remembering the cross-product

$$\vec{a} \times \vec{b} \equiv \det \begin{bmatrix} \vec{i} & \vec{j} & \vec{k} \\ a_x & a_y & a_z \\ b_x & b_y & b_z \end{bmatrix}$$
$$= (a_y b_z - a_z b_y) \vec{i} + (a_z b_x - a_x b_z) \vec{j} + (a_x b_y - a_y b_x) \vec{k}$$

$$\vec{i} = [1 \ 0 \ 0]$$

$$\vec{j} = [0 \ 1 \ 0]$$

$$\vec{k} = [0 \ 0 \ 1]$$

Modeling Transformations

- **Vast majority of transformations are modeling transforms**
- **Generally fall into one of two classes**
 - **Transforms that move parts within the model**

$$\dot{m}_1^t \mathbf{c} \Rightarrow \dot{m}_1^t \mathbf{M} \mathbf{c} = \dot{m}_1^t \mathbf{c}'$$

- **Transforms that relate a local model's frame to the scene's world frame**

$$\dot{m}_1^t \mathbf{c} \Rightarrow \dot{m}_1^t \mathbf{M} \mathbf{c} = \dot{w}^t \mathbf{c}$$

Translations

- Translate points by adding offsets to their coordinates

$$m^t c \Rightarrow m^t T c = m^t c'$$

$$m^t c \Rightarrow m^t T c = w^t c$$

where

$$T = \begin{bmatrix} 1 & 0 & 0 & t_x \\ 0 & 1 & 0 & t_y \\ 0 & 0 & 1 & t_z \\ 0 & 0 & 0 & 1 \end{bmatrix}$$

- The effect of this translation:

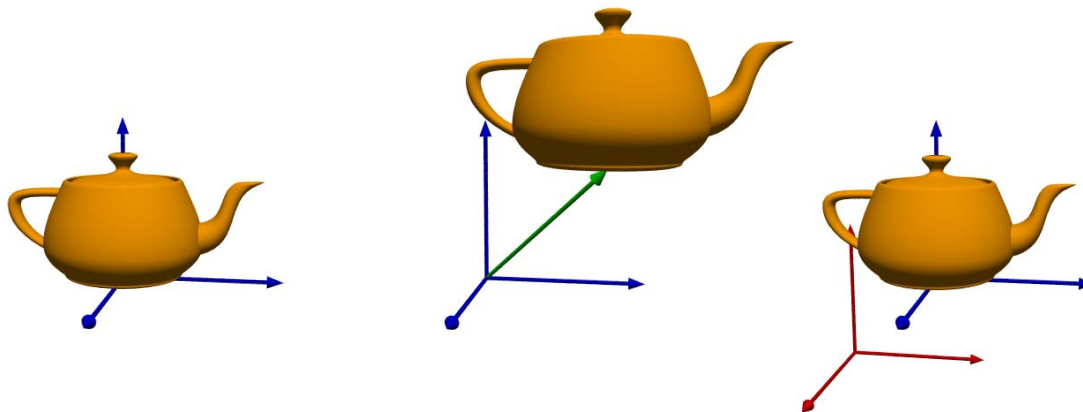

3D Rotations

- **More complicated than 2D rotations**
 - **Rotate objects along a rotation axis**

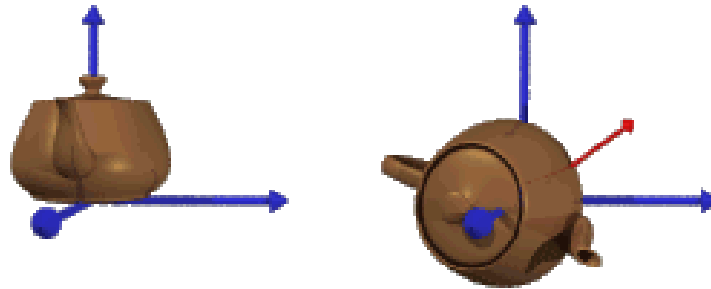

- **Several approaches**
 - **Compose three canonical rotations about the axes**
 - **Quaternions**

Geometry of a Rotation

- **Natural basis for rotation of a vector about a specified axis:**

- \hat{a} - **rotation axis** (normalized)
- $\hat{a} \times \bar{x}$ - **vector perpendicular** to
- \bar{x}_\perp - perpendicular component of \bar{x} relative to \hat{a}

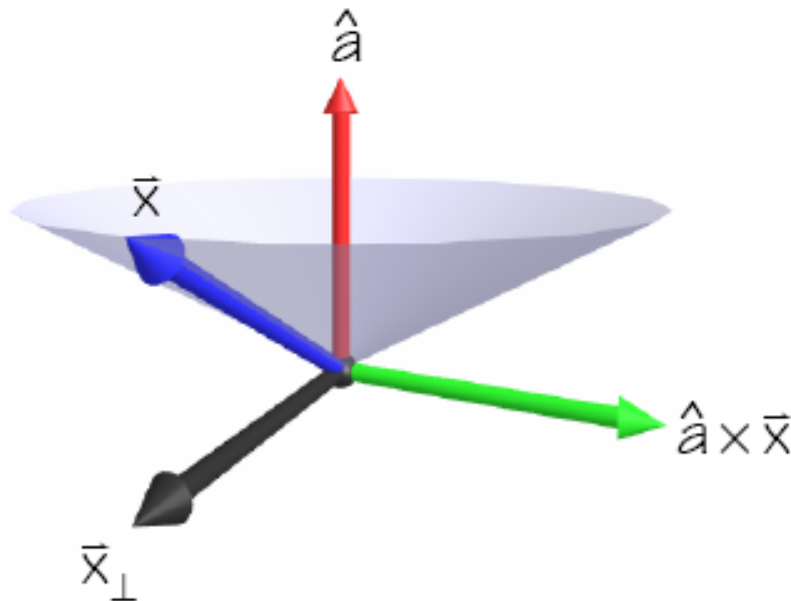

Geometry of a Rotation

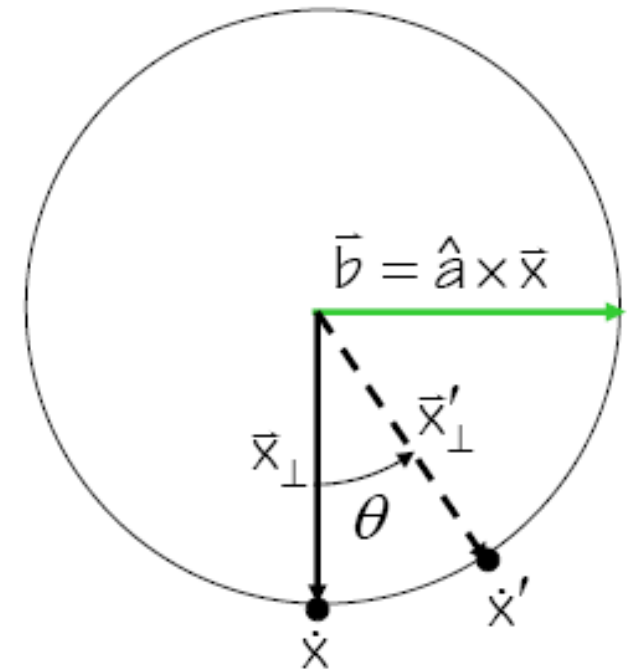
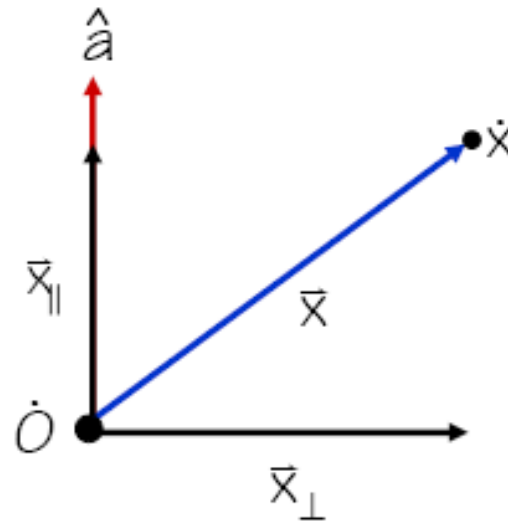
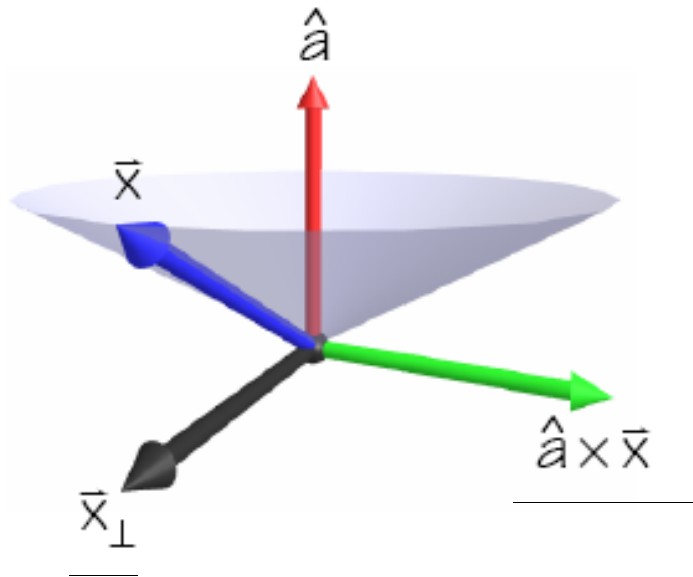

$$\dot{x}' = \dot{O} + x_{\parallel} + \bar{x}'_{\perp}$$

$$\bar{x}'_{\perp} = \cos \theta \bar{x}_{\perp} + \sin \theta \bar{b}$$

$$\bar{x}_{\parallel} = \hat{a}(\hat{a} \cdot \bar{x})$$

$$\bar{x}_{\perp} = \bar{x} - \bar{x}_{\parallel}$$

$$\dot{x}' = \dot{O} + \cos \theta \bar{x} + (1 - \cos \theta)(\hat{a}(\hat{a} \cdot \bar{x})) + \sin \theta(\hat{a} \times \bar{x})$$

$$\mathbf{c}_{\dot{x}'} = \mathbf{M} \mathbf{c}_{\dot{x}}$$

$$\mathbf{M} = \text{diag}(\dot{O}) + \cos \theta \text{diag}([1 \ 1 \ 1 \ 0]^t)$$

$$+ (1 - \cos \theta) \mathbf{A}_{\otimes} + \sin \theta \mathbf{A}_{\times}$$

Tensor Product (\otimes)

$$\vec{a} \otimes \vec{b} \equiv \vec{a} \vec{b}^t = \begin{bmatrix} a_x \\ a_y \\ a_z \\ 0 \end{bmatrix} \begin{bmatrix} b_x & b_y & b_z & 0 \end{bmatrix} = \begin{bmatrix} a_x b_x & a_x b_y & a_x b_z & 0 \\ a_y b_x & a_y b_y & a_y b_z & 0 \\ a_z b_x & a_z b_y & a_z b_z & 0 \\ 0 & 0 & 0 & 0 \end{bmatrix}$$

$$(\vec{a} \otimes \vec{b}) \vec{c} = \begin{bmatrix} (b_x c_x + b_y c_y + b_z c_z) a_x \\ (b_x c_x + b_y c_y + b_z c_z) a_y \\ (b_x c_x + b_y c_y + b_z c_z) a_z \end{bmatrix} = \vec{a} (\vec{b} \cdot \vec{c})$$

- **Creates a matrix that when applied to a vector \vec{c} return \vec{a} scaled by the project of \vec{c} onto \vec{b}**

Tensor Product (\otimes)

- Useful when $\vec{b} = \vec{a}$
- The matrix $\vec{a} \otimes \vec{a}$ is called the symmetric matrix of \vec{a}
 - We shall denote this A_{\otimes}

$$A_{\otimes} = \vec{a} \otimes \vec{a} = \begin{bmatrix} a_x a_x & a_x a_y & a_x a_z & 0 \\ a_y a_x & a_y a_y & a_y a_z & 0 \\ a_z a_x & a_z a_y & a_z a_z & 0 \\ 0 & 0 & 0 & 0 \end{bmatrix}$$

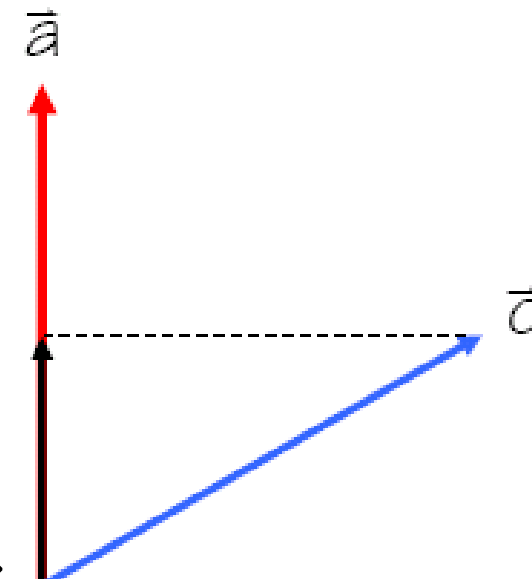

$$\begin{aligned} &= (\vec{a} \otimes \vec{a}) \vec{c} \\ &= \vec{a} (\vec{a} \cdot \vec{c}) \end{aligned}$$

Sanity Check

- Consider a rotation by about the x-axis

$$\text{Rotate}\left(\begin{bmatrix} 1 \\ 0 \\ 0 \\ 0 \end{bmatrix}, \theta\right) = \begin{bmatrix} 0 & 0 & 0 & 0 \\ 0 & 0 & 0 & 0 \\ 0 & 0 & 0 & 0 \\ 0 & 0 & 0 & 1 \end{bmatrix} + \begin{bmatrix} 1 & 0 & 0 & 0 \\ 0 & 1 & 0 & 0 \\ 0 & 0 & 1 & 0 \\ 0 & 0 & 0 & 0 \end{bmatrix} \cos \theta + \begin{bmatrix} 1 & 0 & 0 & 0 \\ 0 & 0 & 0 & 0 \\ 0 & 0 & 0 & 0 \\ 0 & 0 & 0 & 0 \end{bmatrix} (1 - \cos \theta) + \begin{bmatrix} 0 & 0 & 0 & 0 \\ 0 & 0 & -1 & 0 \\ 0 & 1 & 0 & 0 \\ 0 & 0 & 0 & 0 \end{bmatrix} \sin \theta$$

$$= \begin{bmatrix} 1 & 0 & 0 & 0 \\ 0 & \cos \theta & -\sin \theta & 0 \\ 0 & \sin \theta & \cos \theta & 0 \\ 0 & 0 & 0 & 1 \end{bmatrix}$$

- You can check it in any computer graphics book, but you don't need to memorize it

Rotation using Affine Transformation

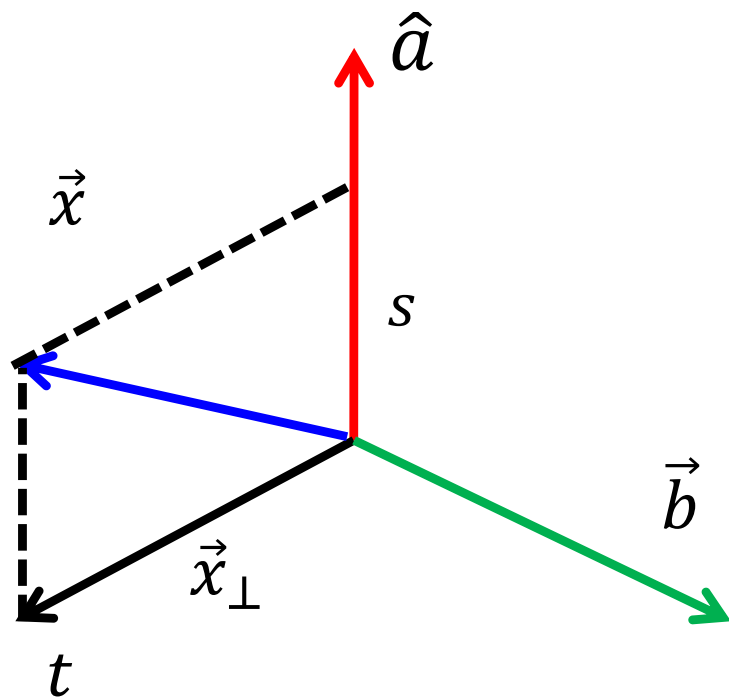

Assume that these basis vectors are normalized

$$\begin{bmatrix} \hat{a} & \vec{x}_{\perp} & \vec{b} & \dot{o} \end{bmatrix} \begin{bmatrix} s \\ t \\ 0 \\ 1 \end{bmatrix}$$

↓

$$\begin{bmatrix} \hat{a} & \vec{x}_{\perp} & \vec{b} & \dot{o} \end{bmatrix} R_x^{\theta} \begin{bmatrix} s \\ t \\ 0 \\ 1 \end{bmatrix}$$

Quaternion

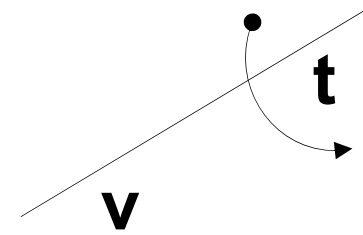

- **Developed by W. Hamilton in 1843**
 - Based on complex numbers
- **Two popular notations for a quaternion, q**
 - $w + xi + yj + zk$, where $i^2 = j^2 = k^2 = ijk = -1$
 - $[w, v]$, where w is a scalar and v is a vector
- **Conversion from the axis, v , and angle, t**
 - $q = [\cos (t/2), \sin (t/2) v]$
 - Can represent rotation
- **Example: rotate by degree a along x axis:**
 $q_x = [\cos (a/2), \sin(a/2) (1, 0, 0)]$

Basic Quaternion Operations

- **Addition**

- $q + q' = [w + w', v + v']$

- **Multiplication**

- $qq' = [ww' - v \cdot v', v \times v' + wv' + w'v]$

- **Conjugate**

- $q^* = [w, -v]$

- **Norm**

- $N(q) = w^2 + x^2 + y^2 + z^2$

- **Inverse**

- $q^{-1} = q^* / N(q)$

Basic Quaternion Operations

- q is a **unit quaternion** if $N(q) = 1$
 - Then $q^{-1} = q^*$
- **Identity**
 - $[1, (0, 0, 0)]$ for multiplication
 - $[0, (0, 0, 0)]$ for addition

Rotations using Quaternions

- **Suppose that you want to rotate a vector/point v with q**
- **Then, the rotated v'**
 - $v' = q r q^{-1}$, where $r = [0, v]$
- **Compositing rotations**
 - $R = R2 R1$ (rotation $R1$ followed by rotation $R2$)

Quaternion to Rotation Matrix

- $Q = w + xi + yj + zk$
- $R_m = \begin{vmatrix} 1-2y^2-2z^2 & 2xy-2wz & 2xz+2wy \\ 2xy+2wz & 1-2x^2-2z^2 & 2yz-2wx \\ 2xz-2wy & 2yz+2wx & 1-2x^2-2y^2 \end{vmatrix}$
- **We can also convert a rotation matrix to a quaternion**

Advantage of Quaternions

- **More efficient and readable way to generate arbitrary rotations**
 - **Less storage than 4 x 4 matrix**
- **Numerically more stable than 4x4 matrix (e.g., no drifting issue)**
 - **Easier for smooth rotation**

Class Objectives were:

- **Know the classic data processing steps, rendering pipeline, for rendering primitives**
- **Understand 3D translations and rotations**

PA2: Simple Animation & Transformation

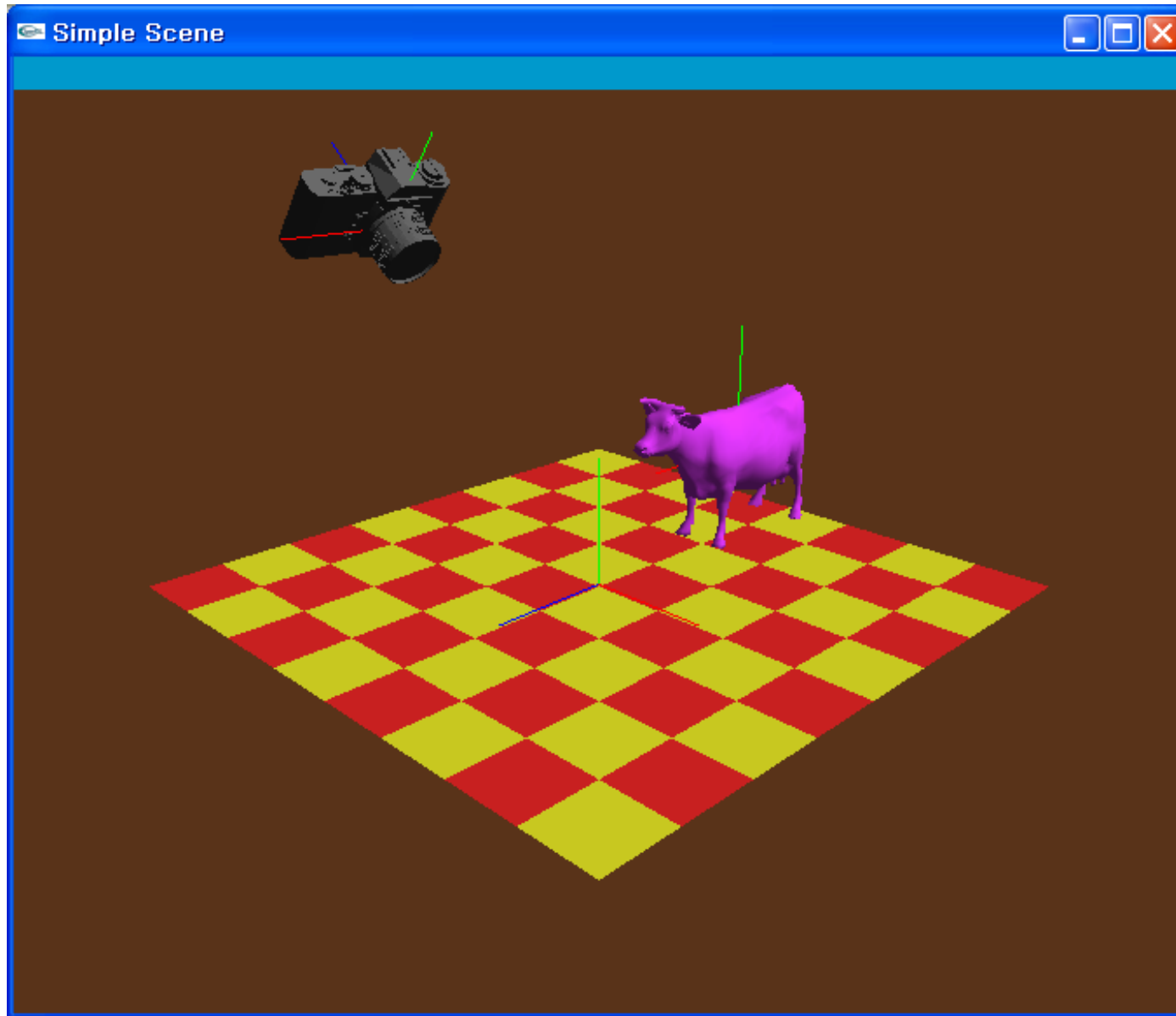

OpenGL: Display Lists

- **Display lists**

- **A group of OpenGL commands stored for later executions**
- **Can be optimized in the graphics hardware**
- **Thus, can show higher performance**
- **Ver. 4.3: Vertex Array Object is much better**

- **Immediate mode**

- **Causes commands to be executed immediately**

An Example

```
void drawCow()
{
  if (frame == 0)
  {
    cow = new WaveFrontOBJ( "cow.obj" );
    cowID = glGenLists(1);
    glNewList(cowID, GL_COMPILE);
    cow->Draw();
    glEndList();
  }

  ..
  glCallList(cowID);
  ..
}
```

API for Display Lists

GLuint **glGenLists** (range)

- generate a continuous set of empty display lists

void **glNewList** (list, mode) & **glEndList** ()

: specify the beginning and end of a display list

void **glCallLists** (list)

: execute the specified display list

OpenGL: Getting Information from OpenGL

```
void main( int argc, char* argv[] )
{
    ...
    int rv,gv,bv;
    glGetIntegerv(GL_RED_BITS,&rv);
    glGetIntegerv(GL_GREEN_BITS,&gv);
    glGetIntegerv(GL_BLUE_BITS,&bv);
    printf( "Pixel colors = %d : %d : %d\n", rv, gv, bv );
    ....
}

void display () {
    ..
    glGetDoublev(GL_MODELVIEW_MATRIX, cow2wld.matrix());
    ..
}
```

Homework

- **Watch SIGGRAPH Videos**
- **Go over the next lecture slides**

Next Time

- **Viewing transformations**